

BL-NMM60 - Wing nuts

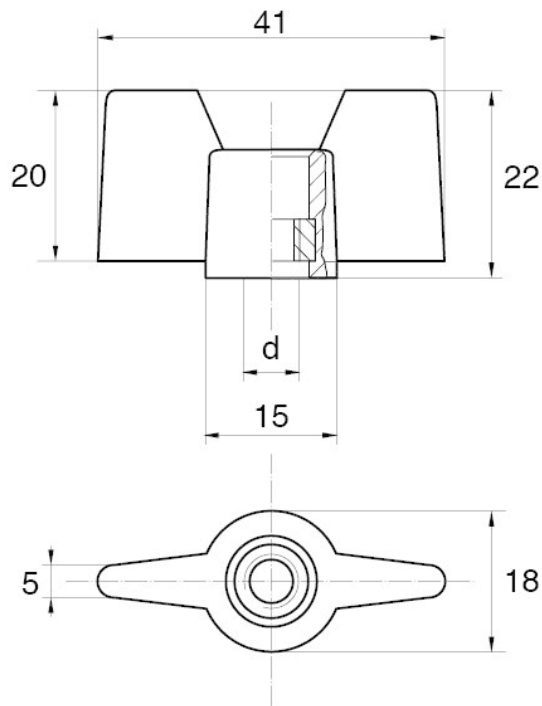

Details:

- **Handle material:** Nylon
- **Thread material:** zinc plated steel; stainless steel or brass available on special order
- **Handle colour:** black; other colours available on special order
- **Type:**
 - F - closed
 - O - open

Symbol	Type	Int. thread d	Standard pack
			[szt./pcs]
BL-NMM60-M6-O	O	M6	2500