

BL-NMM20 - Wing nuts

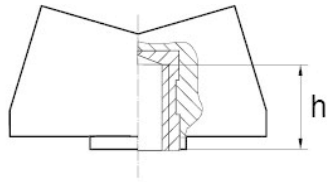

Typ F / Type F

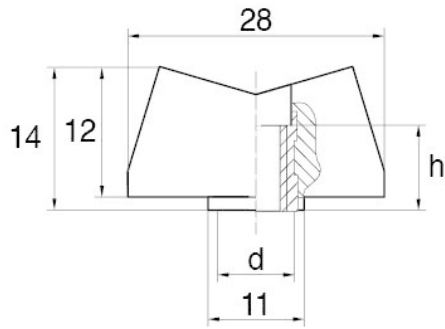

Typ O / Type O

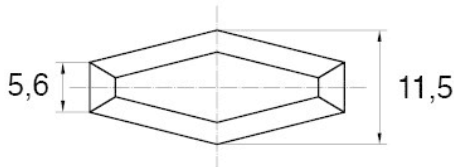

Details:

- **Handle material:** Nylon
- **Thread material:** brass; Stainless steel or brass available on special order
- **Handle colour:** black; other colours available on special order
- Type:
 - F - closed
 - O - open

Symbol	Type	Int. thread d	Int. thread length h	Standard pack
			[mm]	[szt./pcs]
BL-NMM20-M6-O	O	M6	8.5	5000