

BL-HEXTG - Hexagonal spacers with metric thread

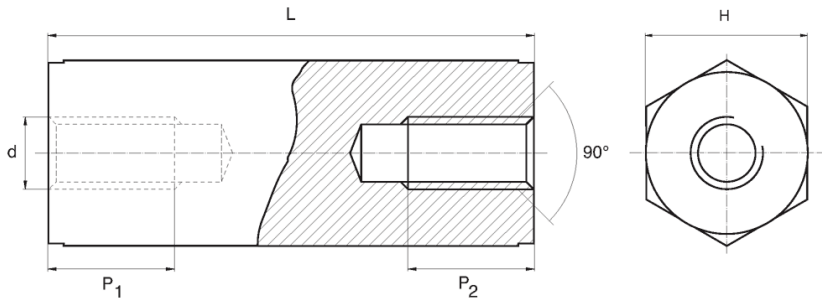

Details:

- **Material:** Nylon, glass-filled
- **Colour:** black
- Colours available on special order: natural, blue, green, red, yellow
- Working temperature: -30°C to +110°C
- Standard pack: 1000 pcs

Symbol	Int. thread d	Wrench size H	Int. thread length P1=P2	Height L	Material	Color
		[mm]	[mm]	[mm]		
BL-HEXTG-M6-09	M6	10	9	9	PA+GF	black