

AR-POS128A - Metalowe podkładki sprężynujące

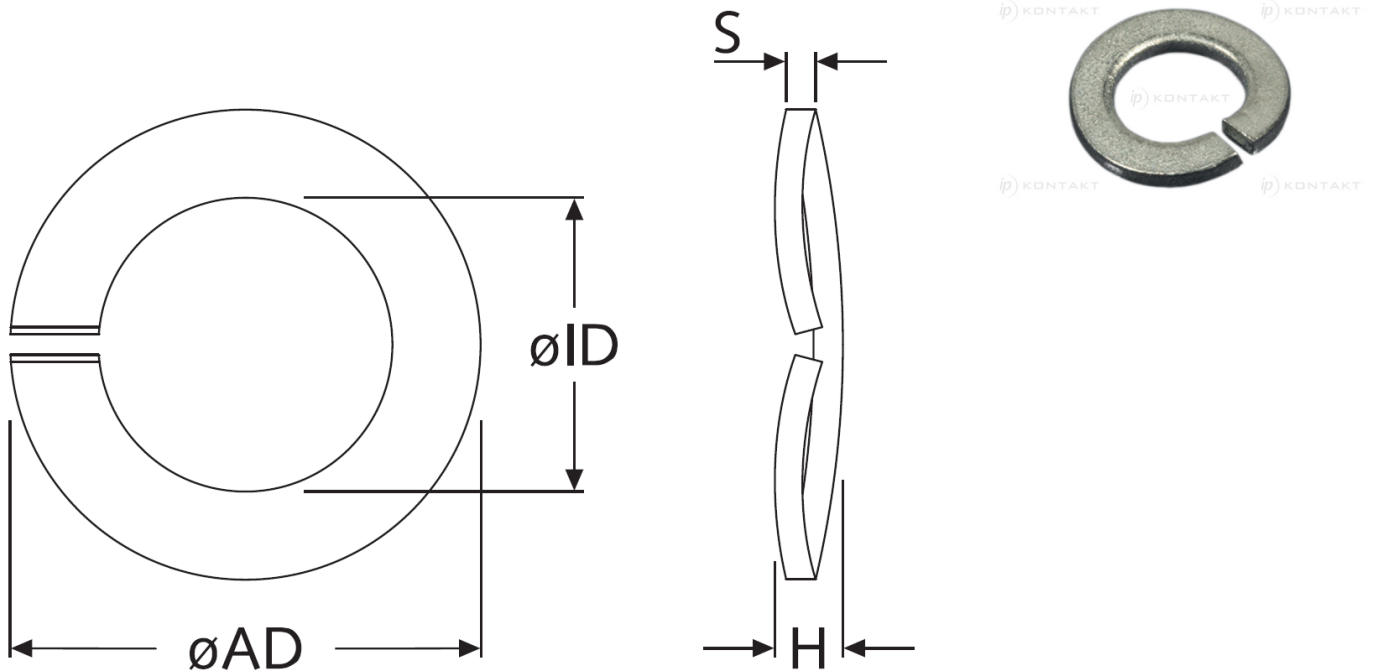

Details:

- Material: see table

Symbol	For thread	Int. diameter $\varnothing ID$	Ext. diameter $\varnothing AD$	Height H max.	S	Material
		[mm]	[mm]	[mm]	[mm]	
AR-POS128A-21289	M8	8.1	14.8	2.8	1.6	zinc-plated steel