

AR-POS127B - Metal split lock washers

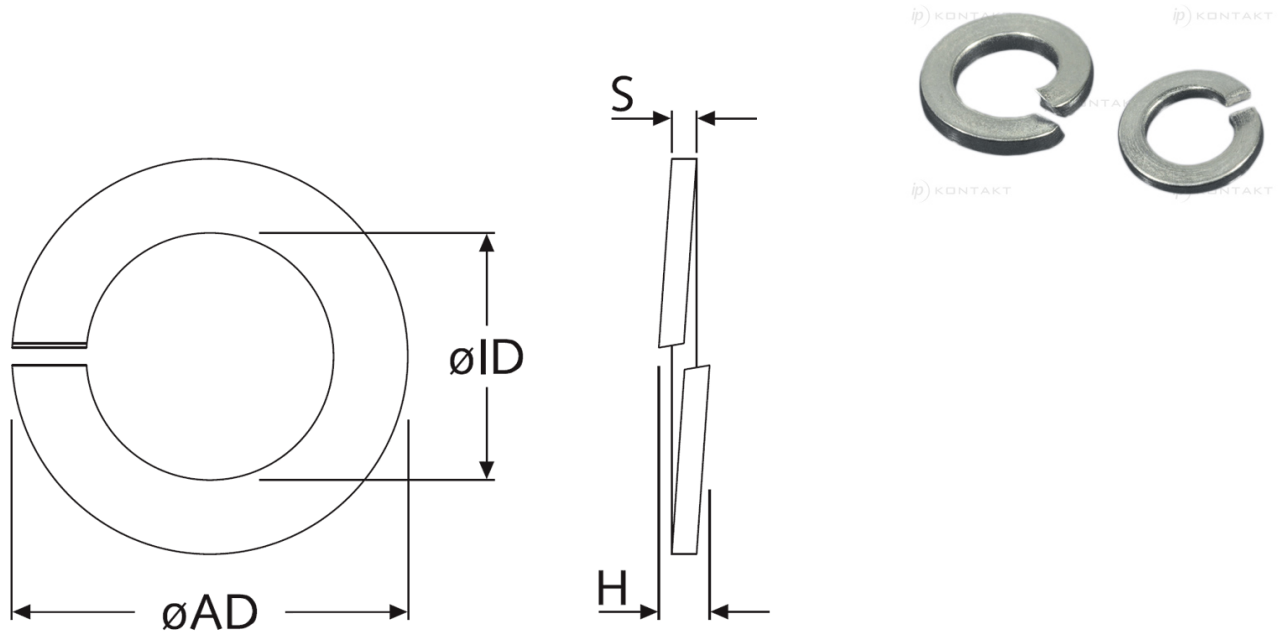

Details:

- Material: see table

Symbol	For thread	Int. diameter øID	Ext. diameter øAD	Height H max.	S	Material
		[mm]	[mm]	[mm]	[mm]	
AR-POS127B-21263	M3	3.1	6.2	1.9	0.8	zinc-plated steel