

FP-9470 - PCB spacers

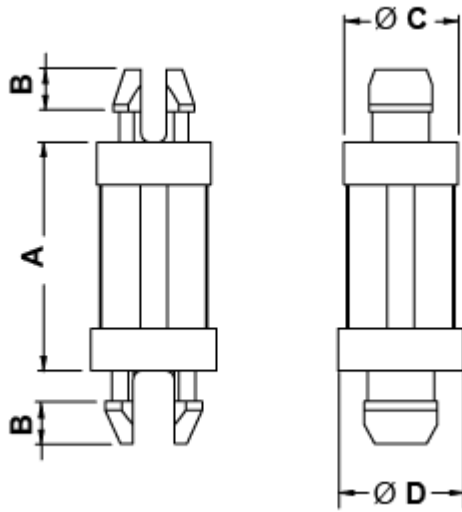

Details:

- **Material: Nylon 6.6**
- **Color: natural**
- Flammability: UL94V2
- Working temperature: -35°C up to +85°C
- Standard pack: 1000 pcs

Symbol	Height A	B	C	D	Top mounting hole dia.	Bottom mounting hole dia.	Top panel thickness	Bottom panel thickness
	[mm]	[mm]	[mm]	[mm]	[mm]	[mm]	[mm]	[mm]
9477AA00	25.4	2.35	6.35	7	4	4	1.6	1.6