

FP-9258 - Metric thread cable glands

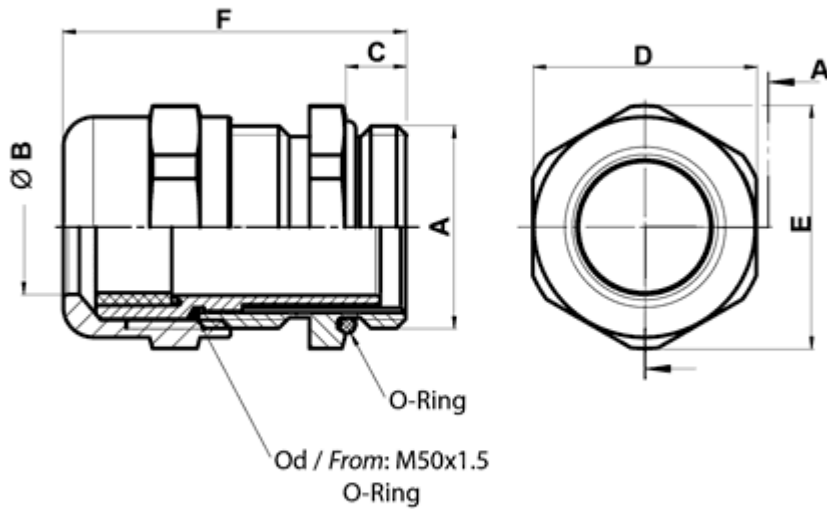

Details:

- **Material: Nickel plated brass**
- **Lamellar insert: PA 6 V-2**
- **Sealing ring: Polychloroprene nitrile**
- Working temperature: -20°C up to +100°C
- Protection grade: IP68 - 5 bar; M12 - M25 - M50 - M63: IP69K
- Metric as per EN 50262

Symbol	Metric thread	Cable diameter range	C	D	E	F	Material	Standard pack
		ØB						[szt./pcs]
		[mm]	[mm]	[mm]	[mm]	[mm]		
9264MA92	M50×1.5	24.0 - 35.0	9	55	60	49.5	brass, nickel plated	5