

**FP-8323 - PCB conductive spacers**

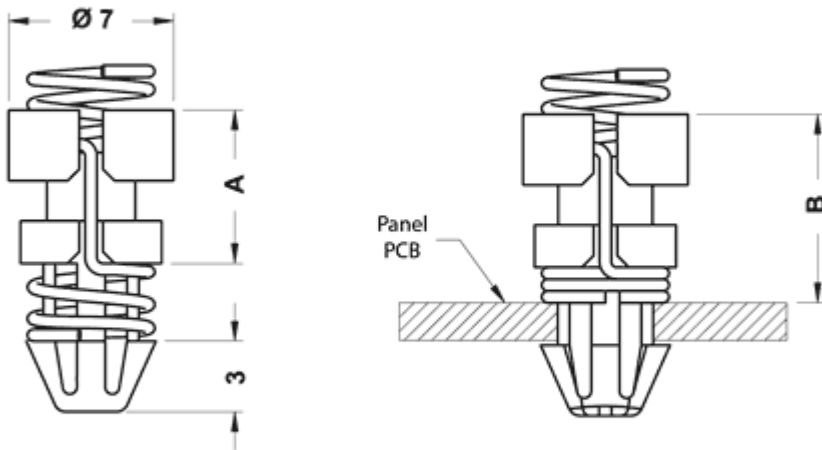
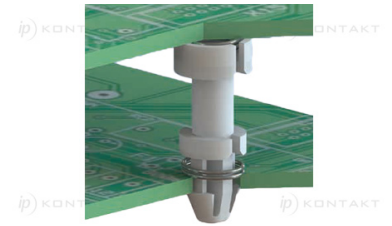

Details:

- **Material: Nylon 6.6**
- **Color: natural**
- Flammability: UL94 V-2
- Spring material: 1.4301
- Working temperature: -35°C up to +85°C
- Standard pack: 1000 pcs

Symbol	A	Height B	Bottom mounting hole dia.	Bottom panel thickness range	Material	Flammability	Color
	[mm]	[mm]	[mm]	[mm]			
8323AA00	6.5	8	4	0.8 - 1.6	PA 66	UL94 V-2	natural