

FP-8212 - Toothed clips

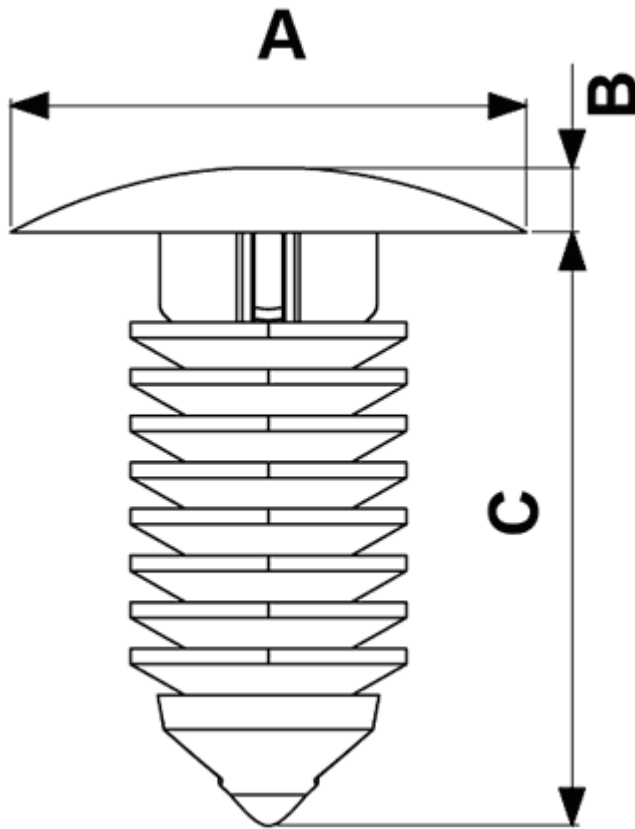

Details:

- **Material: Nylon 6.6**
- **Flammability: UL94V2**
- **Color: black**
- Working temperature: -35°C do +85°C
- Standard pack: 1000 pcs

Symbol	Head diameter ØA	Head height B	C	Mounting hole diameter range	Panel thickness range	Material	Flammability	Color	Notes
	[mm]	[mm]		[mm]	[mm]				
8225AA01	16.6	2.1	19.1	8.7	1.4 - 13.0	PA 66	UL94 V-2	black	-