

FP-6586 - LED spacer support

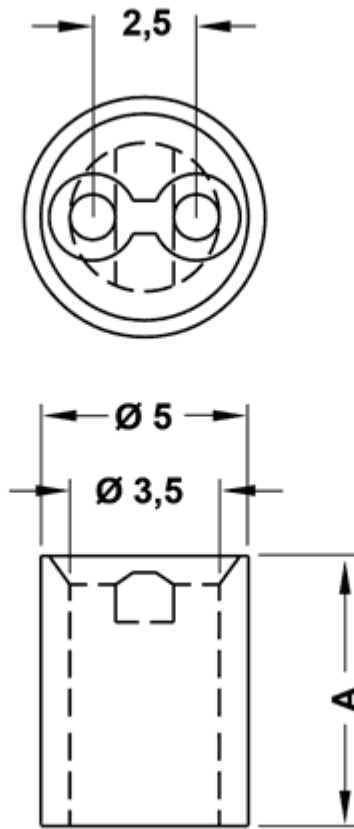

Details:

- **Material: Nylon 6.6**
- **Color: natural**
- Flammability: UL94V2 (V0 on special order)
- Working temperature: -30°C do +85°C
- Standard pack: 2000 pcs

Symbol	Height A	Standard pack	Material	Flammability	Color
	[mm]	[szt./pcs]			
6593AA00	5.5	2000	PA 66	UL94 V-2	natural