

FP-5574 - PCB spacers

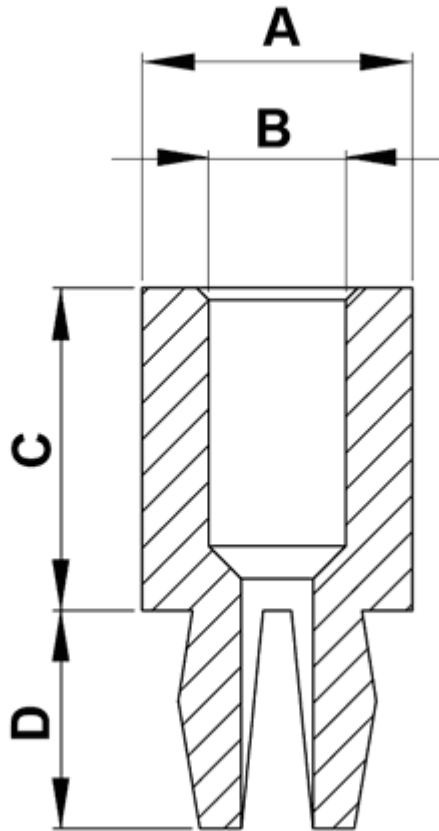

Details:

- **Material: Nylon 6.6**
- **Color: natural**
- Flammability: UL94V2
- Working temperature: -35°C up to +85°C

Symbol	Ext. diameter A	Int. diameter B	Height C	D	Mounting hole	Bottom panel thickness range	Screw	Standard pack
	[mm]	[mm]	[mm]					[mm]
5580AA00	6.7	3.4	15.9	5.4	4.5 x 4.5	0.8 - 2.3	4 P	1000