

FP-0110 - Screw grommets

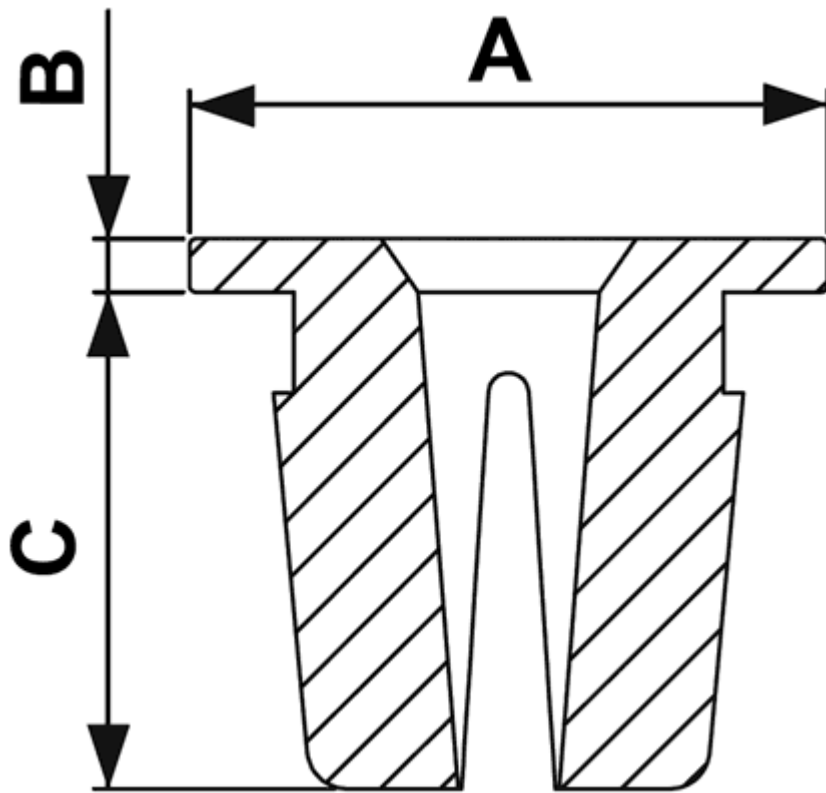

Details:

- **Material:** Nylon 6.6
- **Flammability:** UL94V2
- **Color:** natural
- **Working temperature:** -35°C do +85°C

Symbol	A	B	C	Mounting hole dimensions	Panel thickness range	Notes	Material	Flammability	Color	Standard pack
	[mm]	[mm]	[mm]	[mm]	[mm]					[szt./pcs]
4709AA00	9.5	0.8	7.5	6.5 x 6.5	0.8 - 3.0	ST 3.9 - ST 4.2	PA 66	UL94 V-2	natural	2500