

FP-25240 -

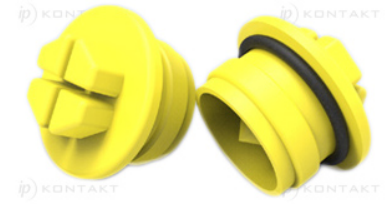
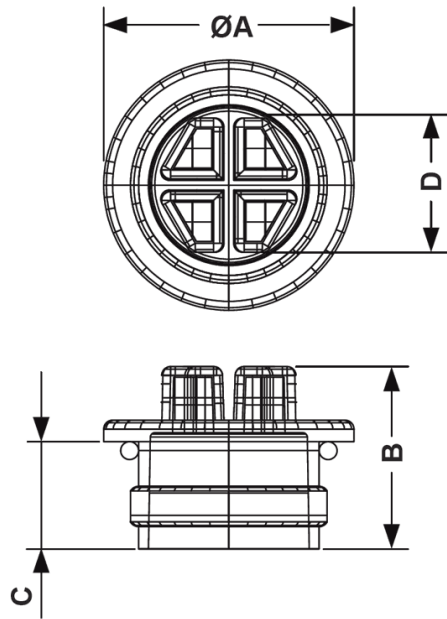

Details:

- **Material: HDPE**
- **Colour: yellow**
- **Working temperature: -25°C to 60°C**

Symbol	Ext. thread	Ext. diameter ØA	B	C	Wrench size D	Material	Color	Standard pack
		[mm]	[mm]	[mm]	[mm]			[szt./pcs]
25263EA06	M26×1.5	32	20.4	12	19	HDPE	yellow	250