

FP-11496 - LED spacer supports

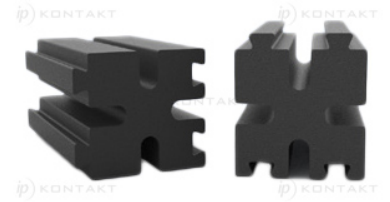
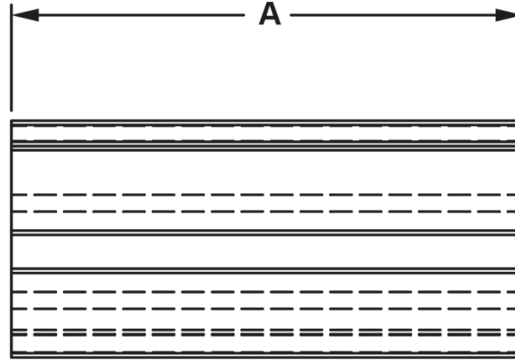
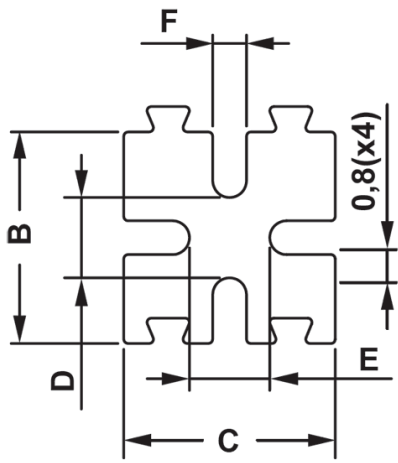

Details:

- **Material: PA 6.6**
- **Flammability: UL94 V-2**
- **Colour: black**
- Working temperature: -35°C to 85°C

Symbol	Height A	B	C	D	E	F	Material	Flammability	Color
	[mm]	[mm]	[mm]	[mm]	[mm]	[mm]			
11496AA0113.0	13	5	5	1.9	1.9	0.8	PA 66	UL94 V-2	black