

FP-11220 - Pull Mount Bumper

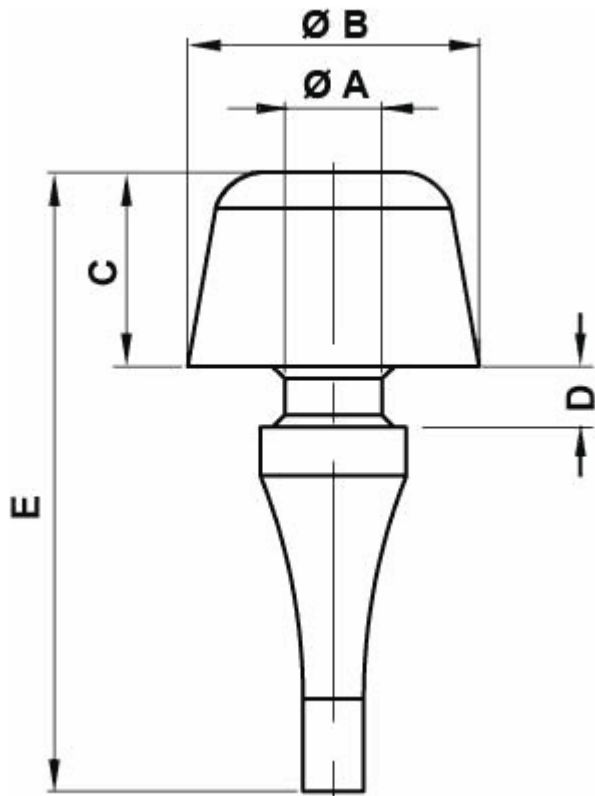

Details:

- **Material:** see table
- **Kolor:** black
- Working temperature:
 - EPDM: -40°C do +120°C
 - NBR: -35°C do +110°C
- Standard pack: see table

Symbol	Mounting hole diameter ØA	Head diameter ØB	Head height C	Panel thickness D	E	Material	Shore A hardness	Color	Standard pack
	[mm]	[mm]	[mm]	[mm]	[mm]				[szt./pcs]
11222GS01	2.5	6	3	2.5	10.5	EPDM	50	black	2500