

FP-10595 - LED spacer

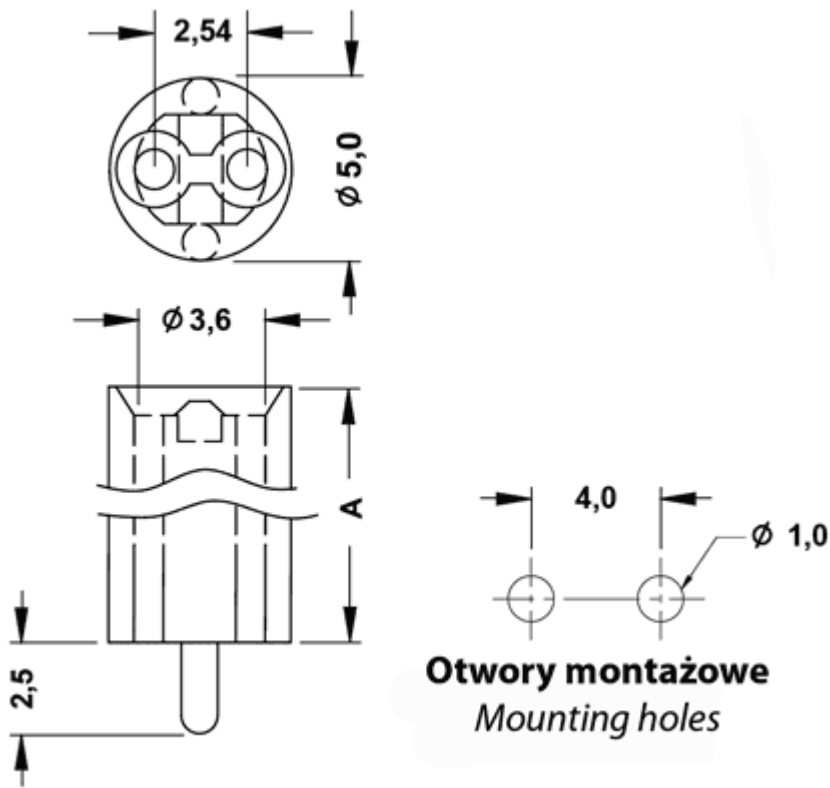

Otwory montażowe
Mounting holes

Details:

- **Material:** Nylon 6.6
- **Color:** natural
- Flammability: UL94V2
- Working temperature: -35°C do +85°C

Symbol	Height A	Standard pack	Material	Flammability	Color
	[mm]	[szt./pcs]			
10597AA00	4	2000	PA 66	UL94 V-2	natural