

FP-0692 - PCB spacer with M4 thread

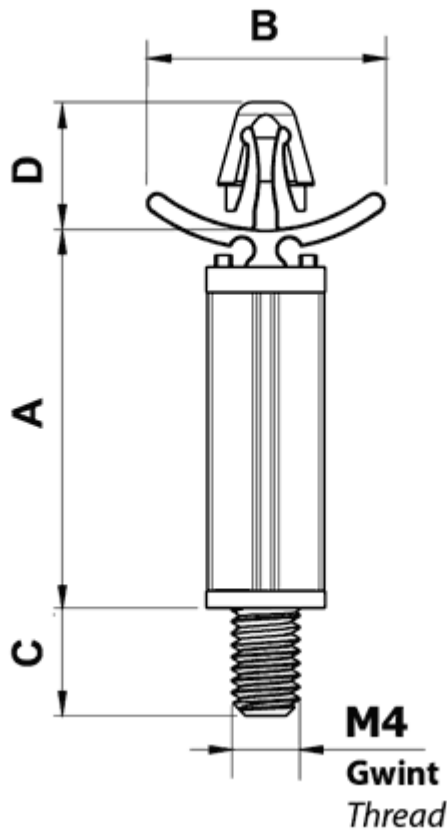

Details:

- **Material: Nylon 6.6**
- **Color: natural**
- Flammability: UL94V2
- Acrylic adhesive working temperature: -35°C up to +85°C

Symbol	Height A	B	Ext. thread length C	Ext. thread	D	Top mounting hole dia.	Top panel thickness range
	[mm]	[mm]	[mm]		[mm]	[mm]	[mm]
0693AA00	9.5	13.5	6.3	M4	7.5	4.8	1.0 - 2.6