

FP-0426 - Push-in feet

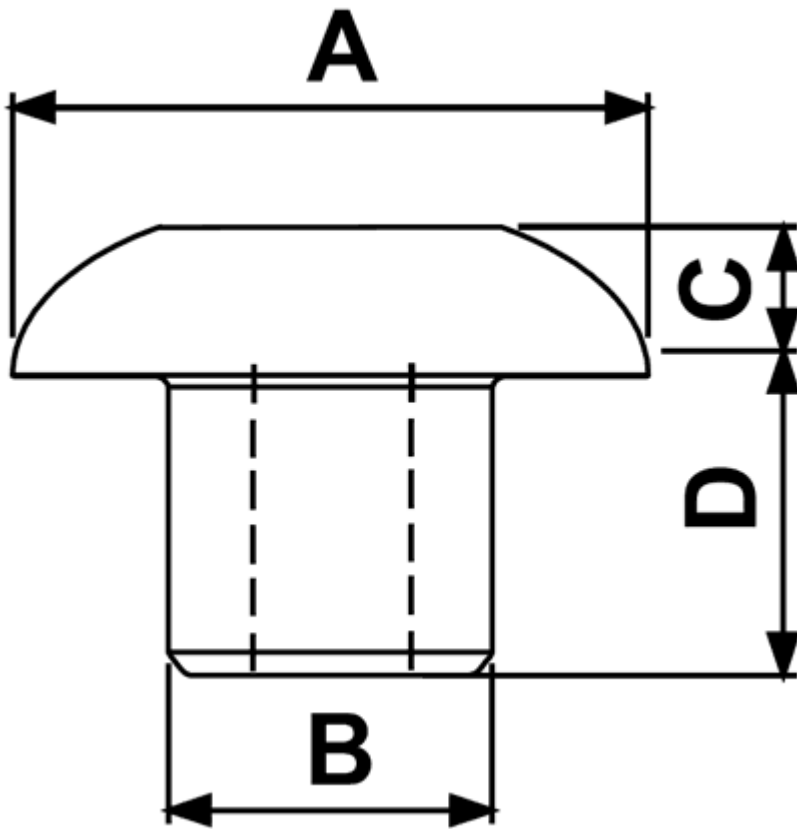

Details:

- **Material: Soft PVC or LDPE**
- **Color: black**
- Working temperature (PVC): -25°C to +60°C
- Working temperature (LDPE): -30°C to +60°C
- Standard pack: 2500 pcs

Symbol	Ext. diameter ØA	ØB	C	D	Material	Color
	[mm]	[mm]	[mm]	[mm]		
0430EA01	20	8	5	15	LDPE	black