

FP-0420 - Nóżki wciskane

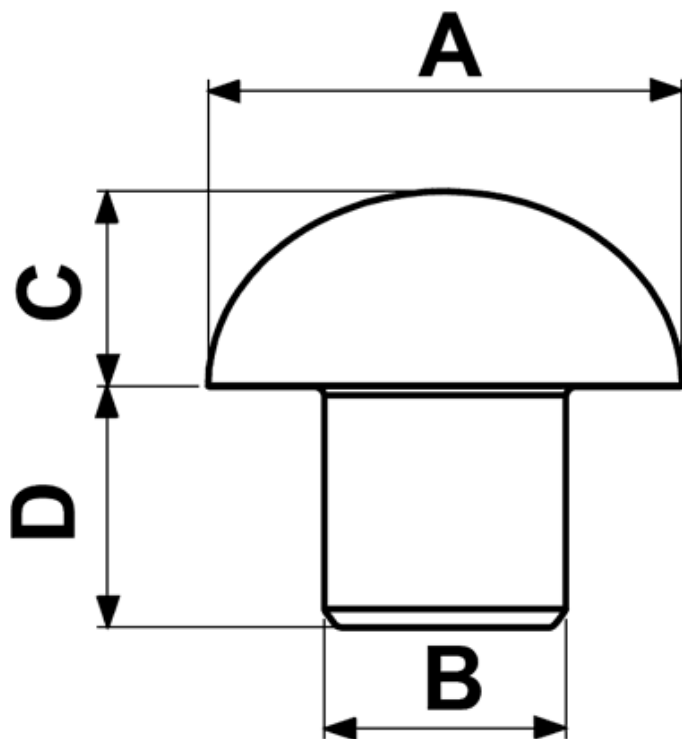

Dane techniczne:

- **Materiał: Miękkie PVC lub LDPE**
- **Kolor: czarny**
- Temperatura pracy (PVC): -25°C do +60°C
- Temperatura pracy (LDPE): -30°C do +60°C

Symbol	A	B	C	D	Materiał	Opakowanie
	[mm]					[szt.]
0420CA01	Ø9.0	Ø5.0	3.0	6.0	Miękkie PVC	2500