

M-NS80 - Stopka wkręcana nastawna stalowa 10°

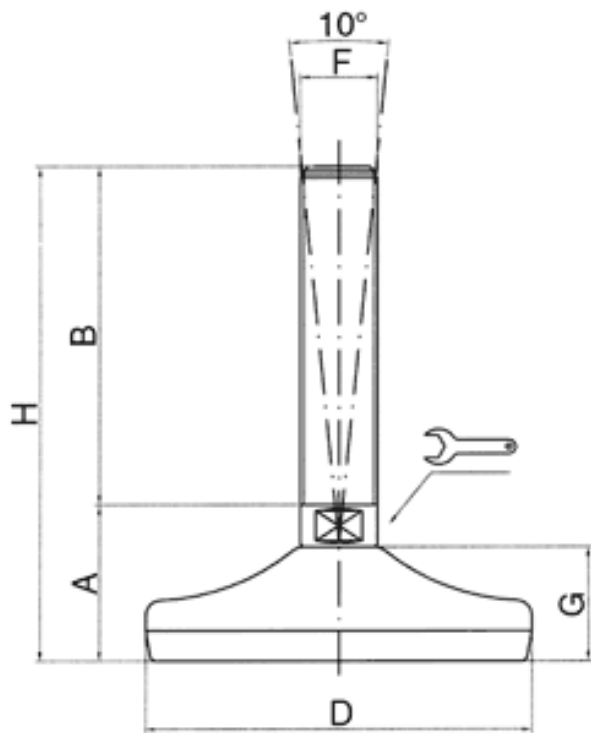

Dane techniczne:

- **Materiał: stal nierdzewna**
- Średnica podstawy: 80 mm
- Maks. obciążenie statyczne: 10000 N

Symbol	A	B	D	SW	F	G	H
	[mm]					[mm]	
M-NS80-M24-225	40	225	80	20	M24	25	265