

M-NS80 - Stopka wkręcana nastawna stalowa 10°

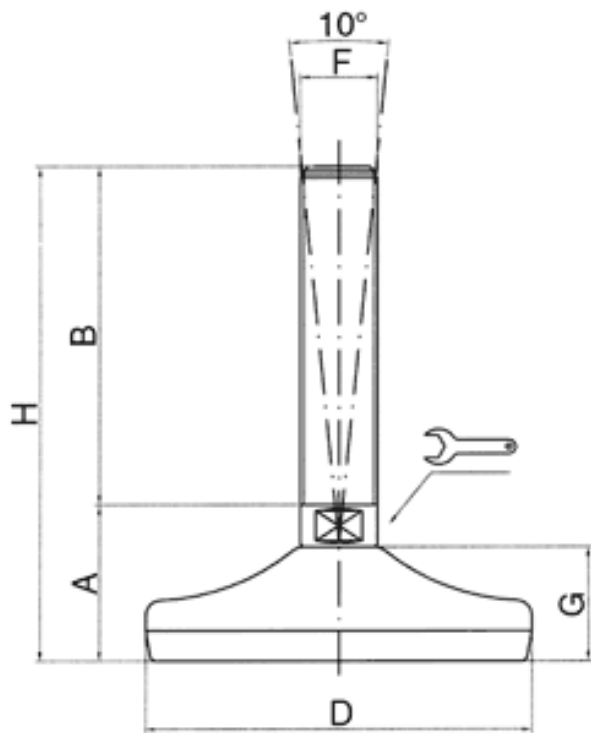

Dane techniczne:

- **Materiał:** stal nierdzewna
- Średnica podstawy: 80 mm
- Maks. obciążenie statyczne: 10000 N

Symbol	A	B	D	SW	F	G	H
	[mm]					[mm]	
M-NS80-M12-100	35	100	80	14	M12	25	135