

M-NSU80 - Stopka wkręcana nastawna stalowa 10°z uchwytem

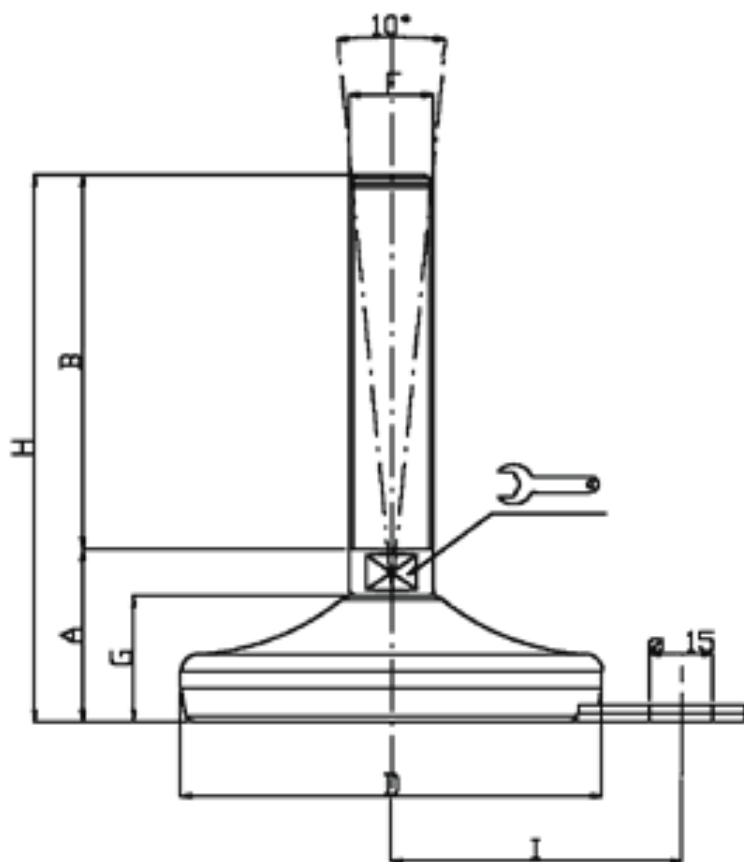

Dane techniczne:

- **Materiał: stal nierdzewna**
- Średnica podstawy: 80 mm
- Maks. obciążenie statyczne: 10000 N

Symbol	A	B	D	SW	F	G	H	I
	[mm]					[mm]		
M-NSU80-M24-200	40	200	80	20	M24	25	240	54