

BM-KNA2 - Kapturki na nakrętki i śruby

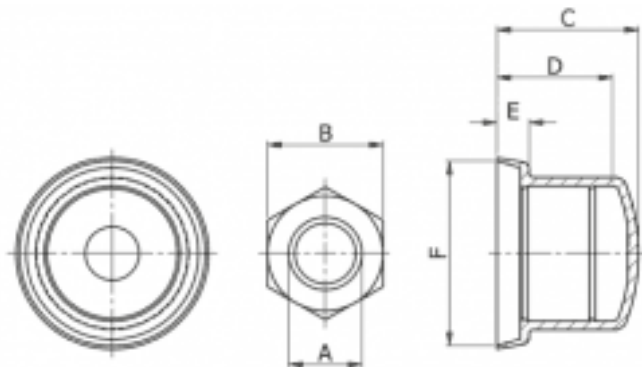

Dane techniczne:

- **Materiał: LDPE**
- **Kolor: czarny, biały**

Symbol	Gwint A	B	C	D	E	F	Kolor
		[mm]					
BM-KNA2-M6-12-WH	M6	10	12	9	2.0	13.2	biały