

FP-3435 - Wkładki do rur okrągłych

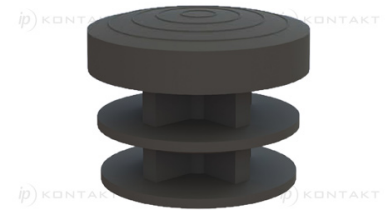
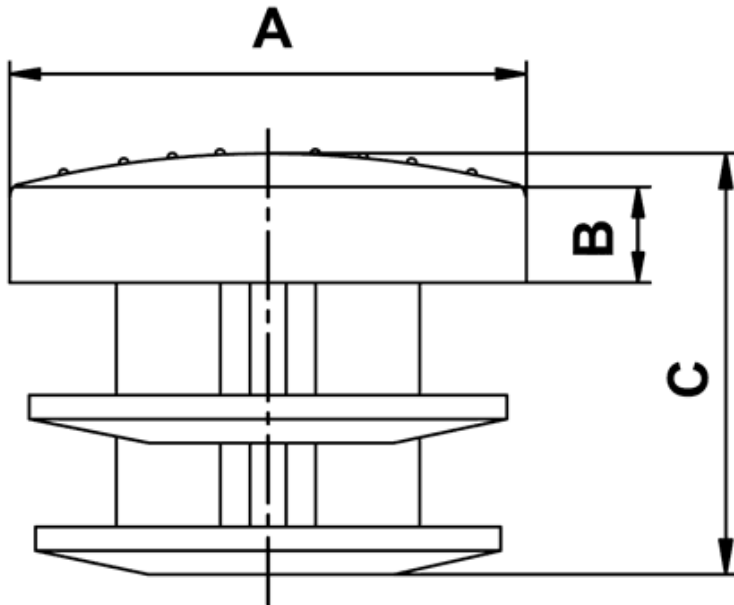

Dane techniczne:

- **Materiał:** LDPE
- **Kolor:** czarny
- **Temperatura pracy:** -30°C do +60°C

Symbol	A	B	C	Opakowanie
	[mm]			[szt.]
3452EA01	Ø50	5.0	22.0	1000