

**FP-3297 - Wkładki do rur kwadratowych**

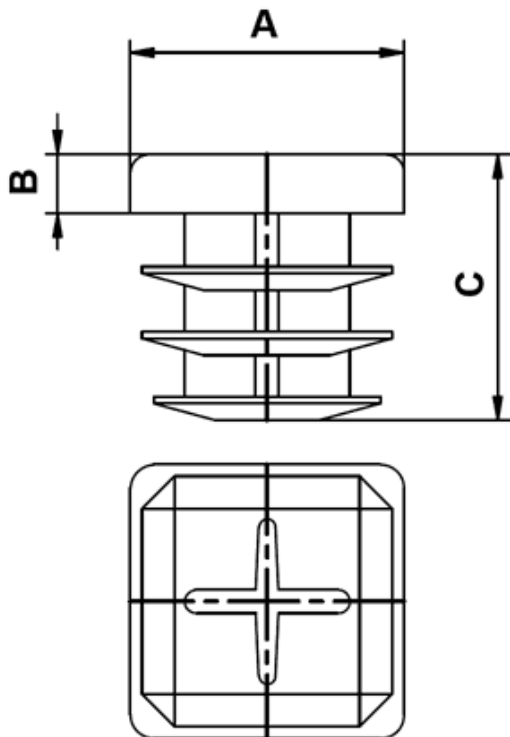

Dane techniczne:

- **Materiał:** LDPE
- **Kolor:** czarny
- **Temperatura pracy:** -30°C do +60°C

Symbol	A	B	C	Opakowanie
	[mm]			[szt.]
3306EA01	40.0	6.0	21.0	1000