

FP-3297 - Wkładki do rur kwadratowych

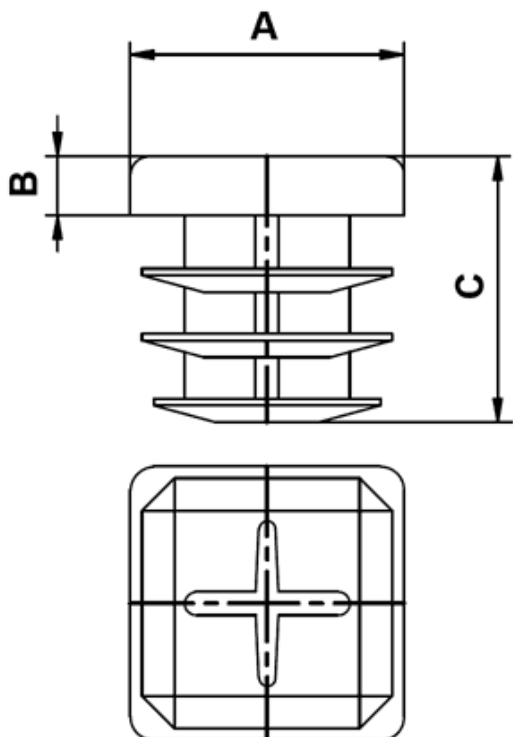

Dane techniczne:

- **Materiał:** LDPE
- **Kolor:** czarny
- **Temperatura pracy:** -30°C do +60°C

Symbol	A	B	C	Opakowanie
	[mm]			[szt.]
3301EA01	20.0	5.0	17.0	1000