

FP-6144 - Uchwyty do opasek kablowych

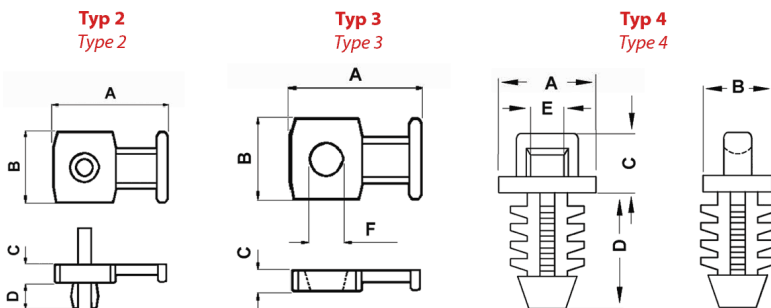
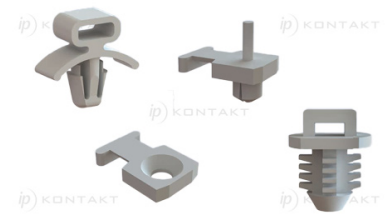
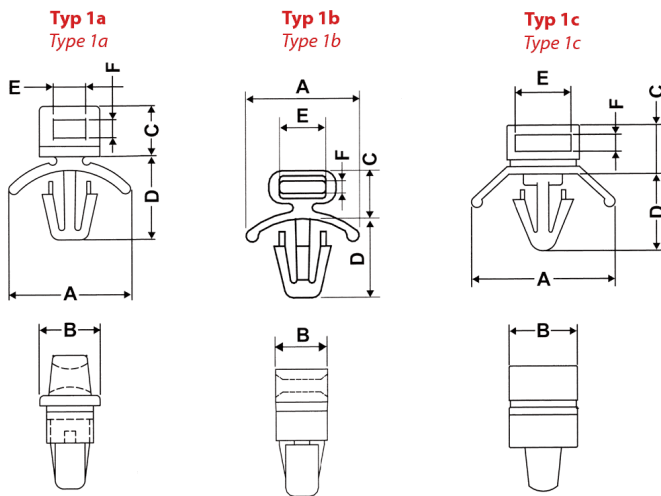

Dane techniczne:

- **Materiał:** PA 6.6 UL94V2
- **Kolor:** naturalny
- Temperatura pracy: -35°C - 85°C
- Opakowanie: 1000 szt.

Symbol	Typ	A	B	C	D	E	F	Otwór	Grubość panelu
		[mm]							
4791AA00	2	18.9	12.7	3.0	5.1	5.0	-	5.0	0.8 - 3.0