

**FP-OPK - Otwarty przepust kablowy**

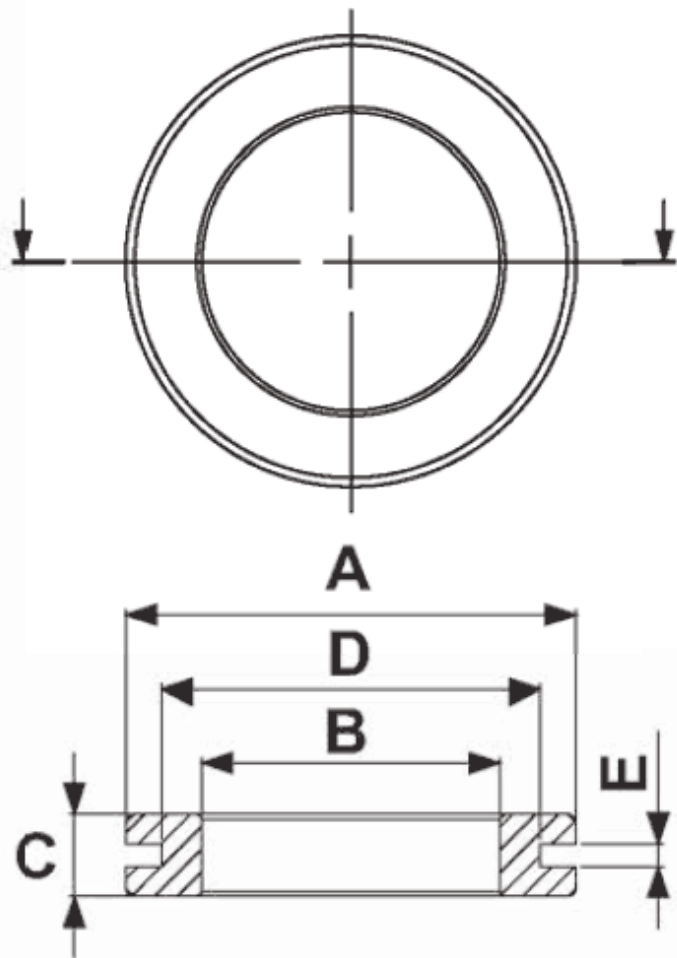

**Dane techniczne:**

- **Materiał:** PVC lub TPE na zamówienie
- **Kolor:** czarny
- **Temperatura pracy:**
  - PVC: od -25°C do +60°C
  - TPE: od -28°C do +90°C

Symbol	A	B	C	D	E	Opakowanie
	[mm]					[szt.]
4500CA01	39.0	28.0	9.0	34.0	4.0	1000