

FP-OPK - Otwarty przepust kablowy

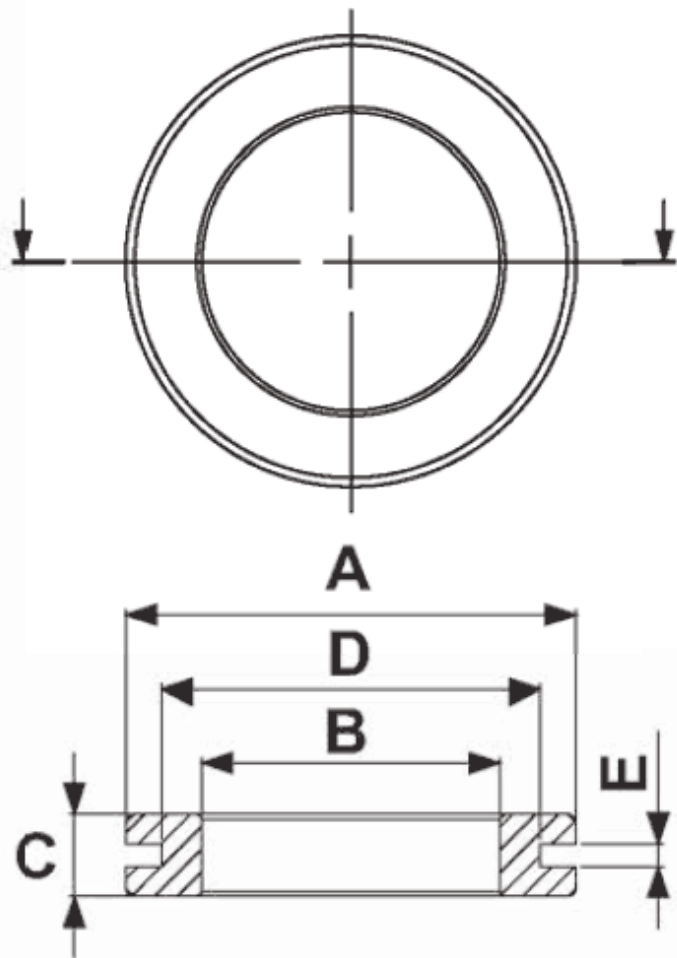

Dane techniczne:

- **Materiał:** PVC lub TPE na zamówienie
- **Kolor:** czarny
- Temperatura pracy:
 - PVC: od -25°C do +60°C
 - TPE: od -28°C do +90°C

Symbol	A	B	C	D	E	Opakowanie
	[mm]					[szt.]
0824CA01	16.0	4.0	6.0	11.0	0.5	1000