

**FP-10438 - Plastikowe nakrętki ślizgowe**

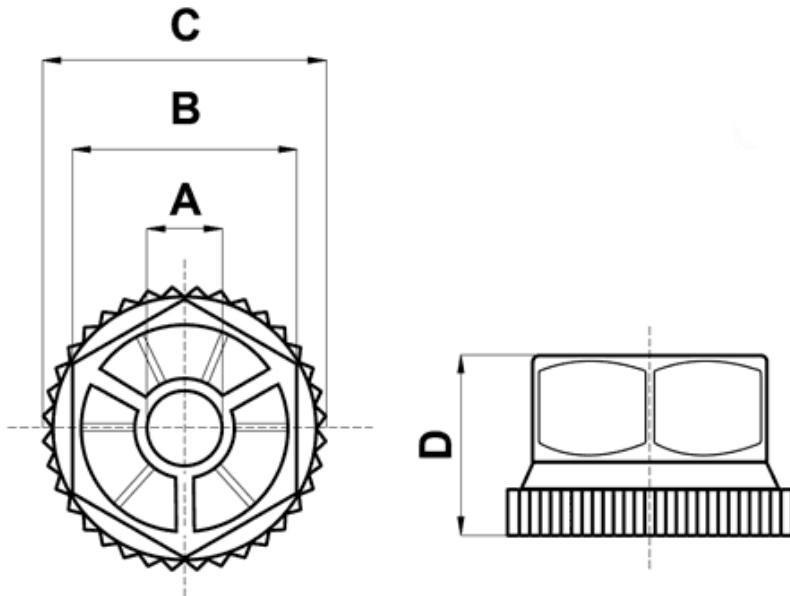

Dane techniczne:

- **Materiał: PA 6.6**
- **Kolor: czarny**
- Temperatura pracy: -30°C do +100°C

Symbol	A	B	C	D	Opakowanie
	[mm]				[szt.]
10441AA01	M6	13.0	15.2	7.0	1000