

FP-1055 - Nakrętki radełkowane

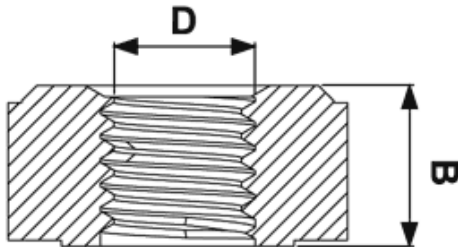
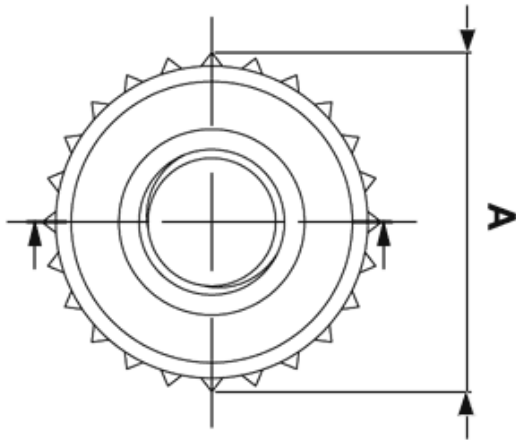

Dane techniczne:

- **Materiał:** PA 6.6 25%GF
- **Klasa palności:** UL94HB
- **Kolor:** biały lub czarny
- Temperatura pracy: -35°C do +100°C

Symbol	A	B	D	Opakowanie	Kolor
	[mm]			[szt.]	
1059BB01	17.5	8.3	M8 x 1.25	1000	czarny