

O-PK - Flange Cover

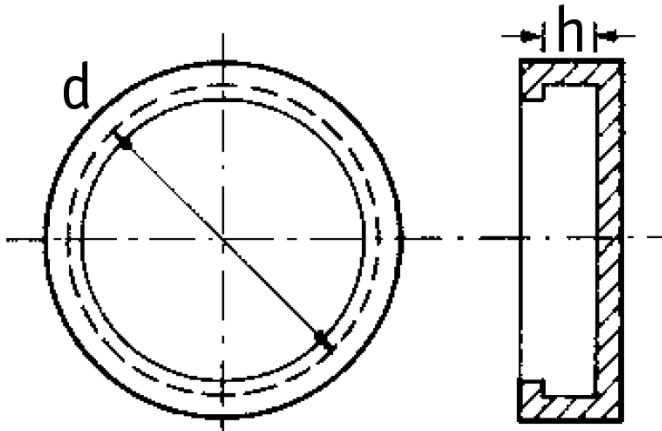

Details:

- **Material: Flexible Polyethylene**
- **Color: Yellow**
- **Ideal for protecting internally-coated flanges**
- **Provide complete all-round flange protection**
- **Cover ANSI B 16.5, DIN 26312635 and BS4504**
- **Easy to fit**
- **Durable and flexible**
- **Also protect bolt holes**
- **Suit all types of flange faces**
- **Standard pack: 100pcs**

Part No.	Nominal diameter	Series pressure group		d	h
		[Bar]	[lbs]		
O-PK-036-235	DN 100	25, 40	-	235.0	21.0