

PGM - Push Grommet Hole Plug M Series

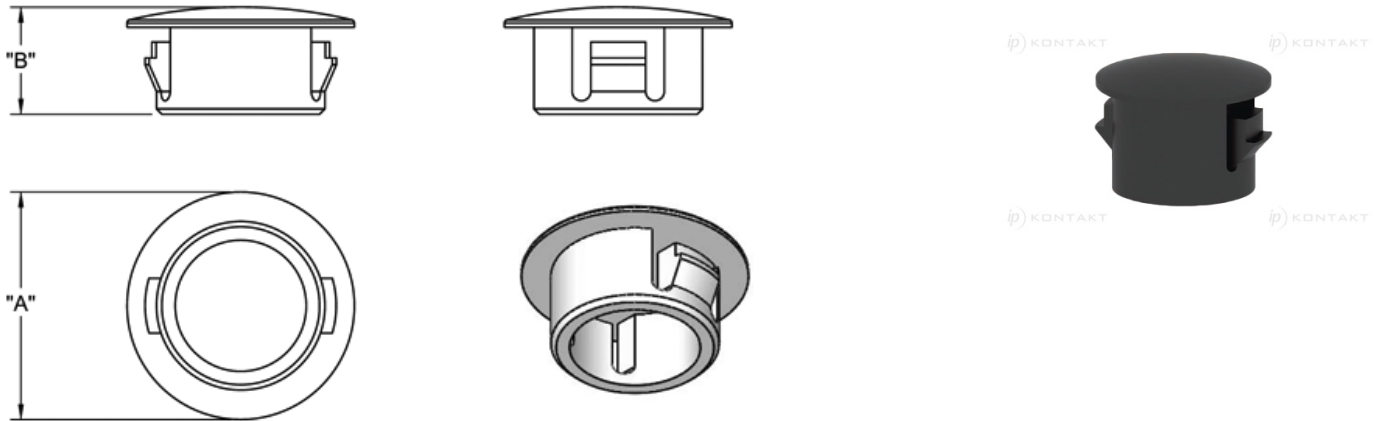

Details:

- **Material:** UL94 V2 Nylon 6/6, RMS-01*
- **Color:** black or white
- **Standard Pack:** see table

Part No.	Mounting hole diameter	Max. panel thickness	A	B	Colour	Standard pack
	[mm]					[pcs]
PGM-7	7.1	1.6	11.0	7.0	BLK	1000