

FP-9672 - Wire saddle, self-adhesive

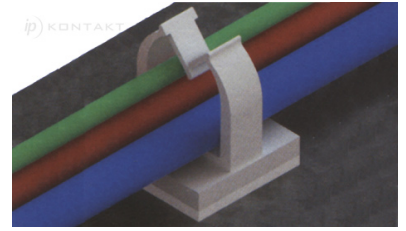
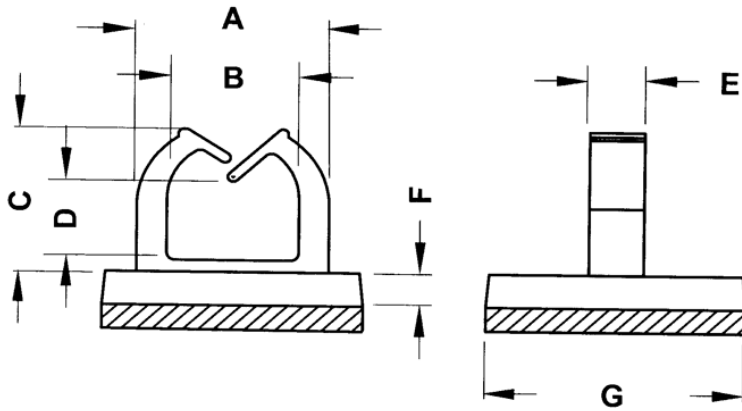

Details:

- **Material:** PA 6.6 UL94V2
- **Color:** natural
- Body working temperature: -35°C - 85°C
- Acrylic adhesive working temperature: **-20°C - 80°C**
- Standard pack: see table

Part No.	A	B	C	D	E	F	G	Standard pack
	[mm]							[pcs]
9673AA00AS	7.0	4.6	6.0	3.3	2.0	1.6	9.4	1000